

Typ 900.10.011

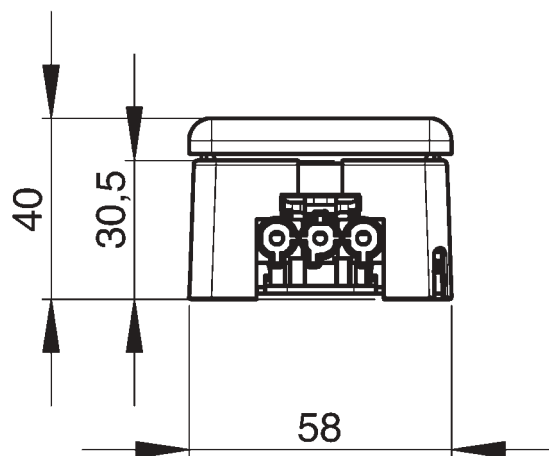

Typ 901.10.011

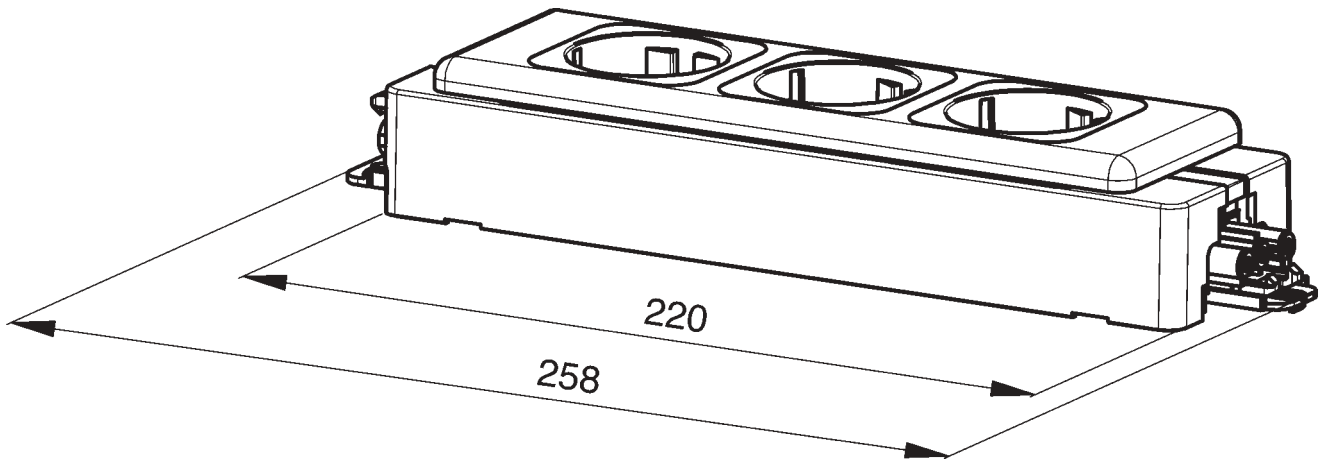

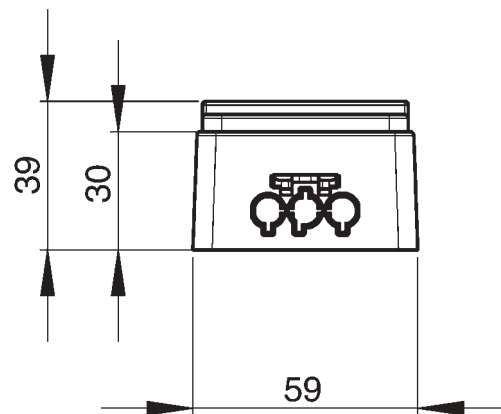
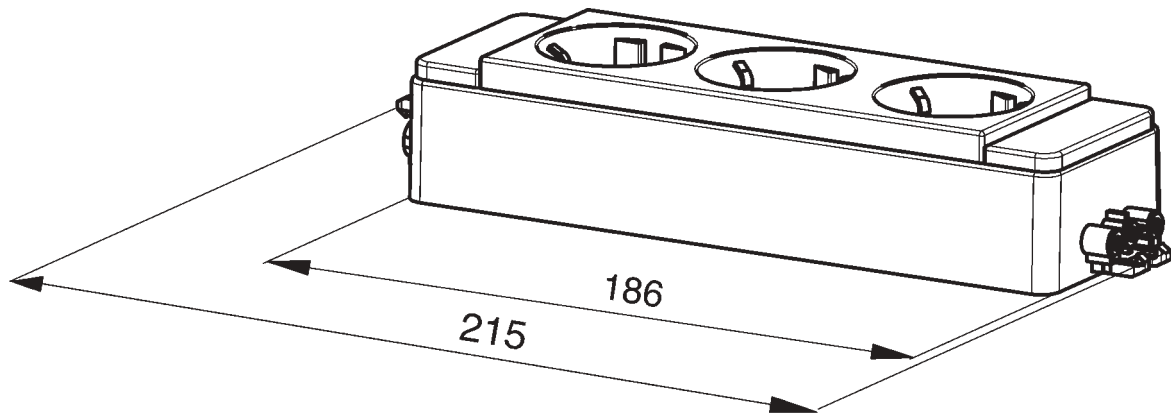

Typ 922.11.041

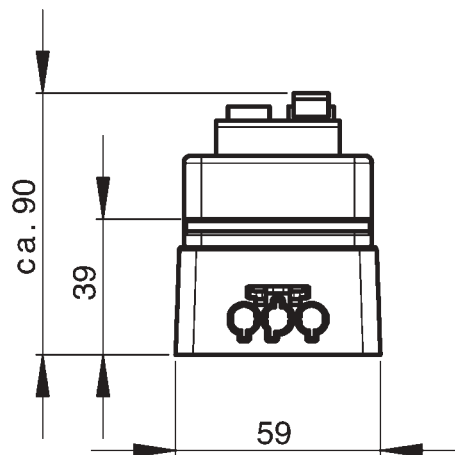
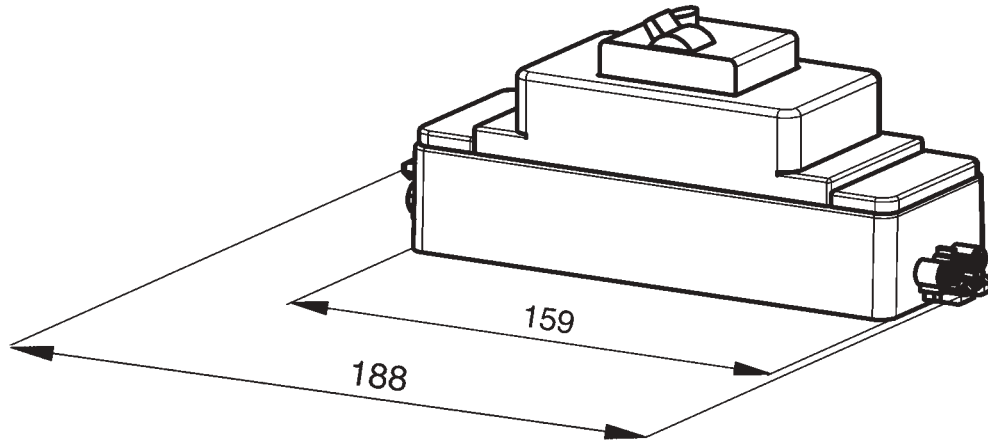

Typ 920.11.031

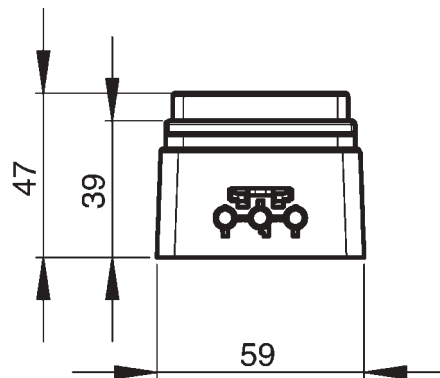
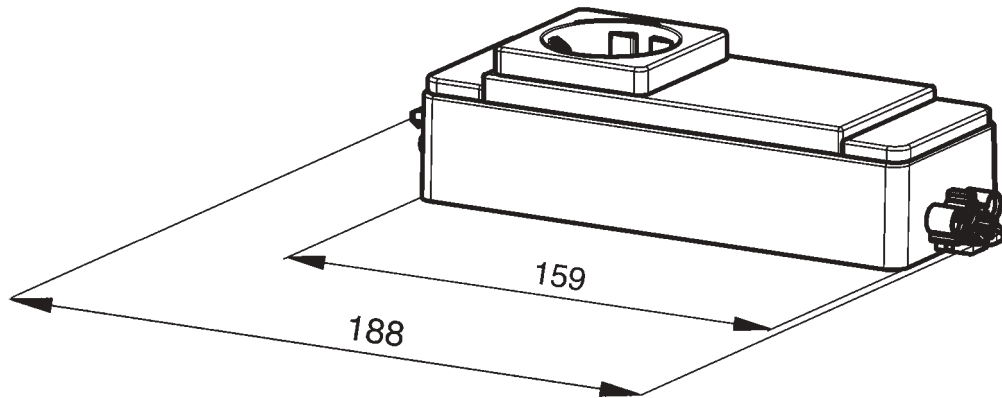

Typ 922.11.031

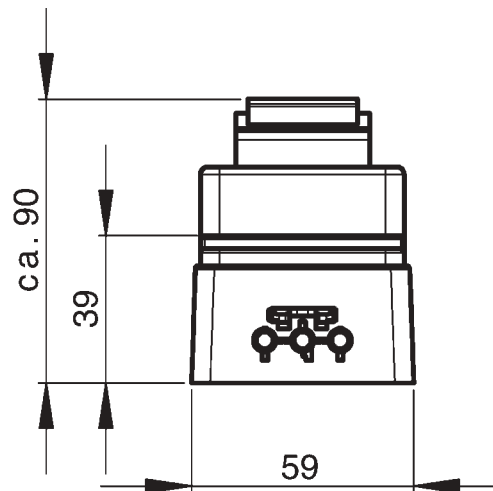
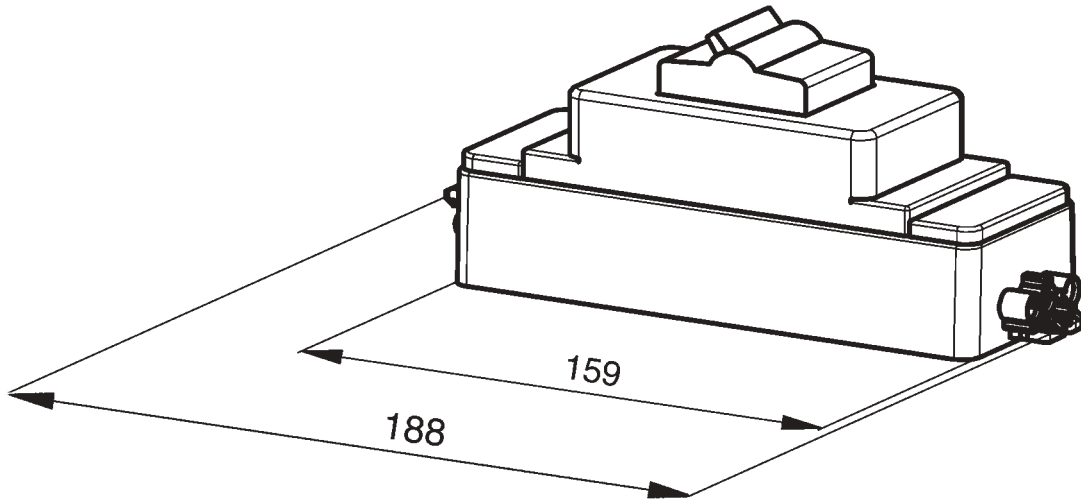

Typ 920.11.041

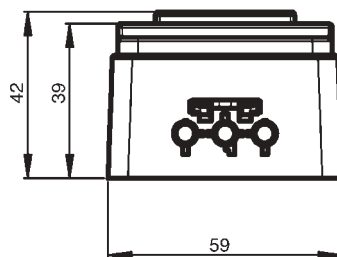
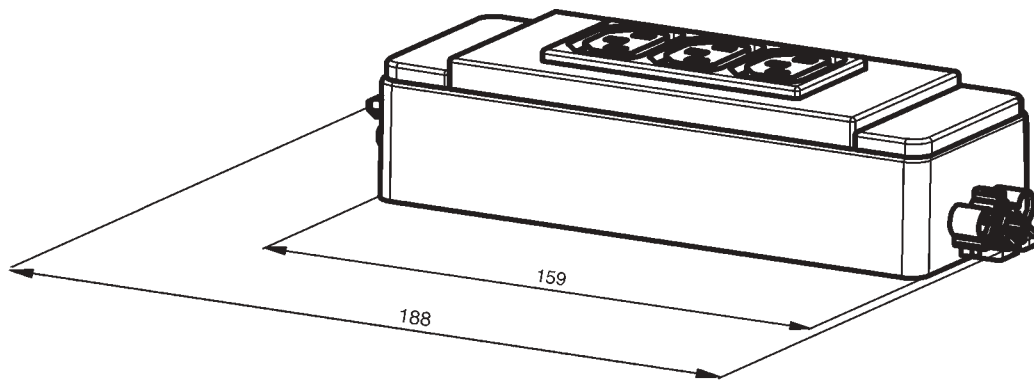

Typ 920.11.091

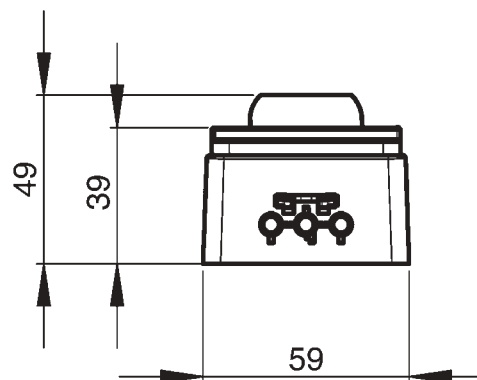
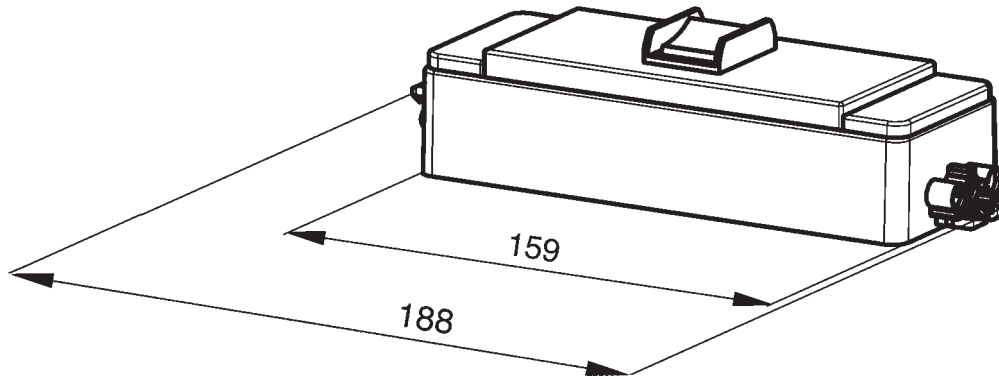



Typ 920.10.101

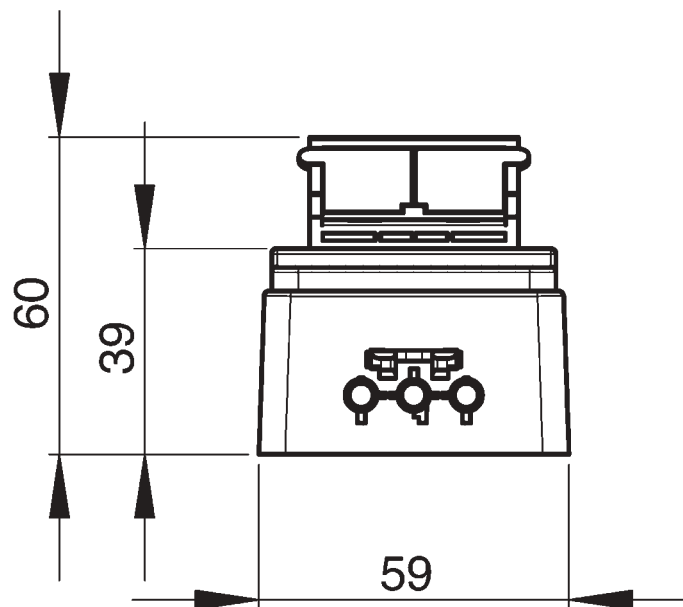
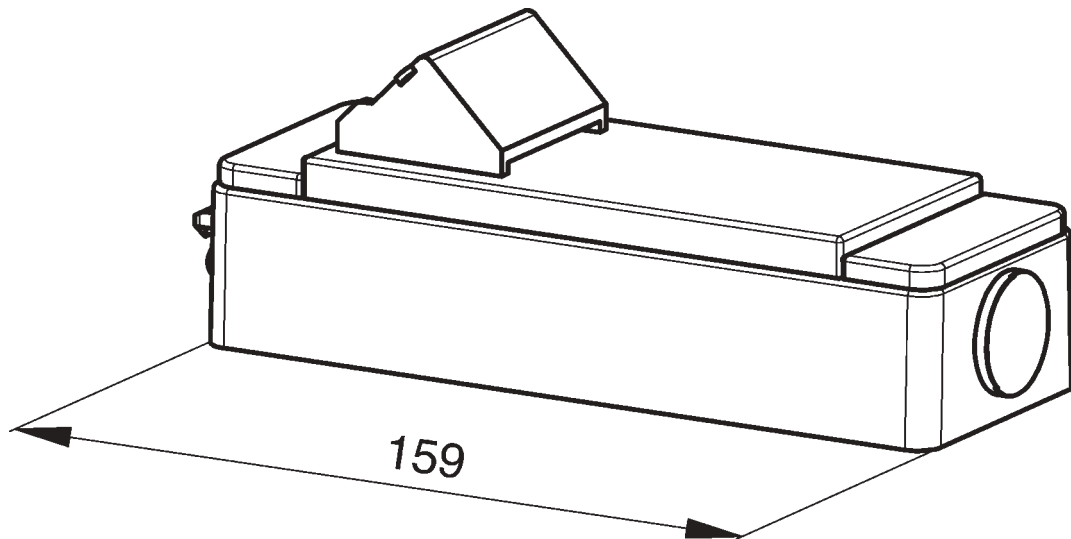

Typ 920.10.131

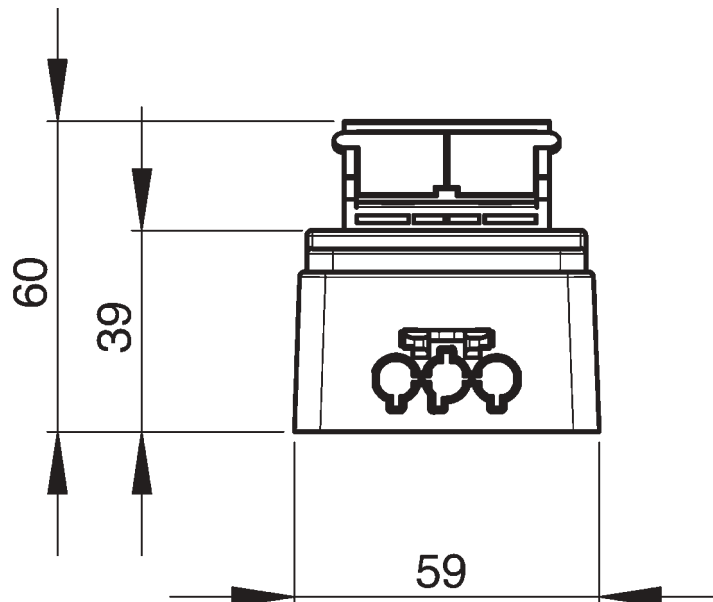
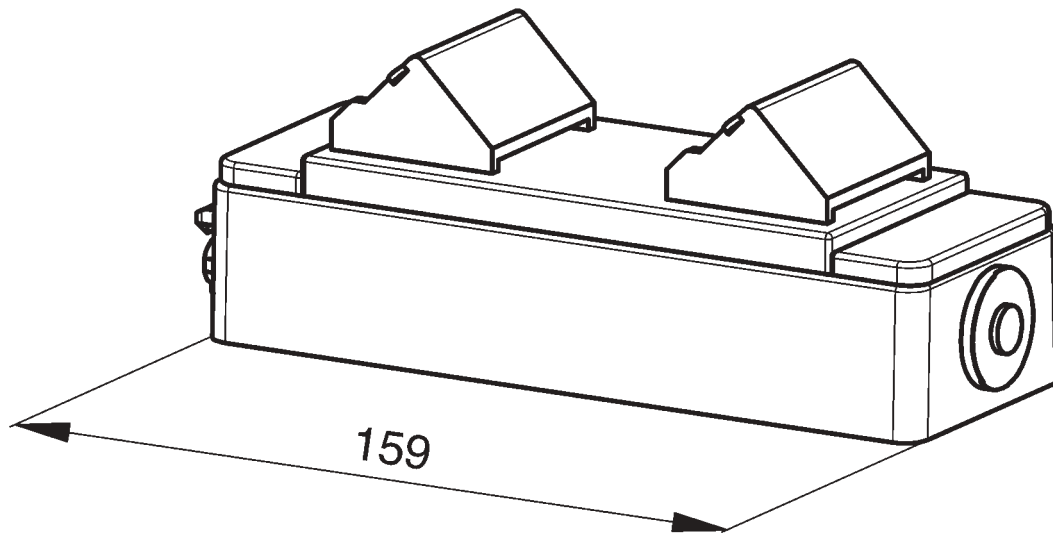

Typ 920.10.051

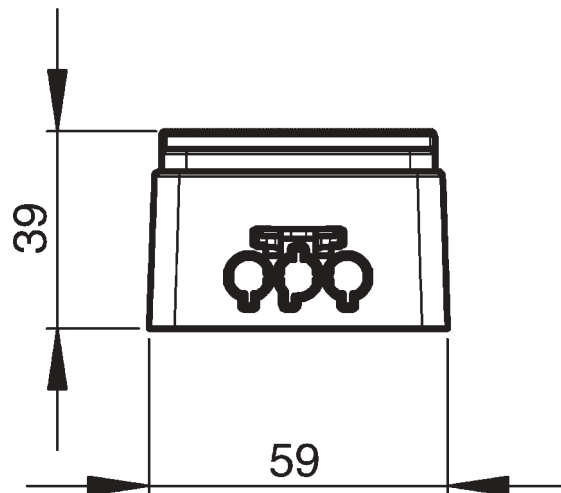
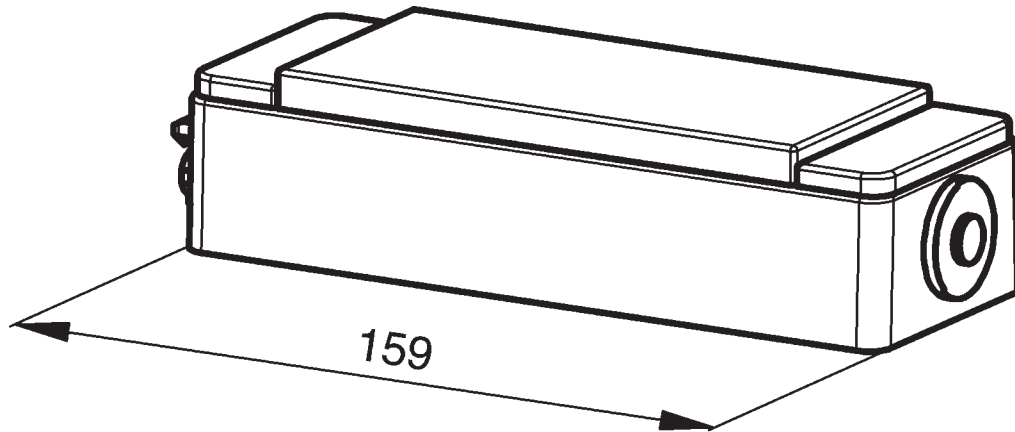

Typ 911.10.021

